

## Wetroom Floors



**Product Guide**

**marmox**  
**showerlay**  
 Floor level shower base

**marmox**  
**decotray**  
 Floor level shower tray

**marmox**  
**minilay**  
 Point & Linear Drain Kits



At Marmox we supply a range of products for waterproofing & insulating.

Well known for the Marmox Multiboards, used to coat floors and walls and then tiled, plastered or rendered, we also supply a range of wetroom floor solutions that can work hand in hand with Multiboards to create a complete wetroom.

It's easier than ever to create a sloping wetroom floor, ready for tiling. Several options are available to meet different needs, including various size floor formers and drainage systems, which make it easy to create a bespoke floor slope.

### Why use Marmox Wetroom Floor Products?



#### FULLY WATERPROOF

All of our wetroom floor systems allow for a completely waterproof wetroom or bathroom floor. Various accessories are available for further waterproofing.



#### LIGHTWEIGHT & EASY TO CUT

Marmox Showerlays are polystyrene (XPS) based and offer a very lightweight, trimable solution which is easy to cut with a saw and clean to handle.



#### EFFECTIVE DECOUPLING

The combination of the rigid outer shell and the XPS core, which absorbs lateral movement, makes for an effective decoupling layer.



#### MARMOX LIFETIME GUARANTEE

Marmox product range comes with a Lifetime Guarantee for total peace of mind.

## Marmox Wetroom Floors

There are 5 different drainage options in the Marmox UK range. This includes both linear and square drain options.



**Linear Drain**  
*Pre-formed slope*



**Key Benefits**

- Pre-formed fall ready to receive tiles
- Lightweight
- Quick & easy to install
- Waterproof fleece

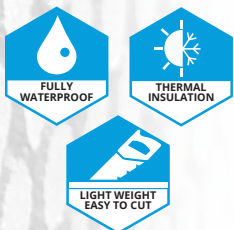

**Linear style floor level shower base**

Showerlay Linears are constructed from high density polystyrene, extruded to the precise shape and dimensions required to ensure a suitable flow rate to the in-built drain. Marmox foam is coated on both sides with a fibreglass mesh embedded in a unique blend of Marmox cement polymer mortar, then topped with a waterproof fleece. The fleece overlaps by 100mm, which can be adhered down to joining substrate, creating a waterproof joint & peace of mind.

Linears are 40mm thick on the perimeter with a stylish brushed stainless steel linear channel grate. They feature a height adjustable drain grate to match the height of thicker tiles when necessary.

Find out more, including fitting instructions at:  
[www.marmox.co.uk](http://www.marmox.co.uk)

**Sizes**

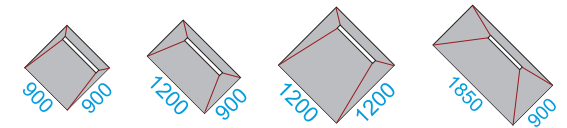

**Drain Parts**

Choose your grate  
**Tileable, Circles or Lines**

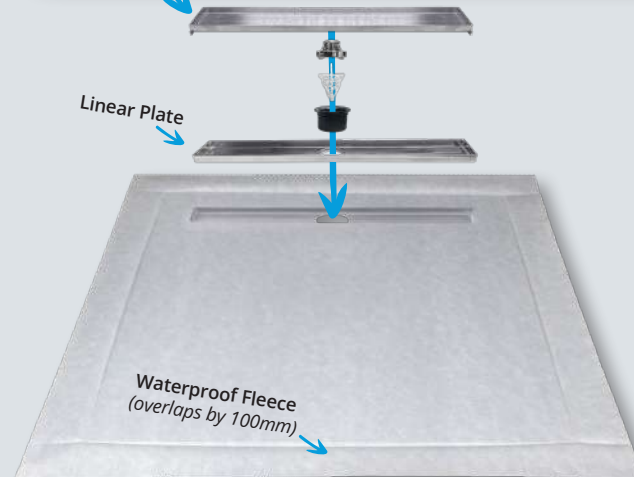

**Drain Height (mm)**



Data	
Product	Performance Litres per min
360°	30

**Square Drain**  
*Pre-formed slope*



**Key Benefits**

- Pre-formed fall ready to receive tiles
- Lightweight
- Quick & easy to install
- Waterproof fleece

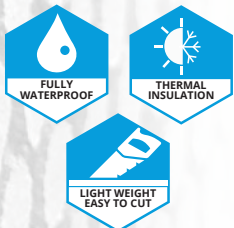

**Square drain style floor level shower base**

Showerlays are constructed from high density polystyrene, extruded to the precise shape and dimensions required to ensure a suitable flow rate to the in-built drain. Marmox foam is coated on both sides with a fibreglass mesh embedded in a unique blend of Marmox cement polymer mortar, then topped with a waterproof fleece. The fleece overlaps by 100mm, which can be adhered down to joining substrate, creating a waterproof joint & peace of mind.

Showerlays are 20-24mm thick on the perimeter (depending on size) with a brushed stainless steel grate in various locations. They feature a height adjustable drain grate.

Find out more, including fitting instructions at:  
[www.marmox.co.uk](http://www.marmox.co.uk)

**Sizes**

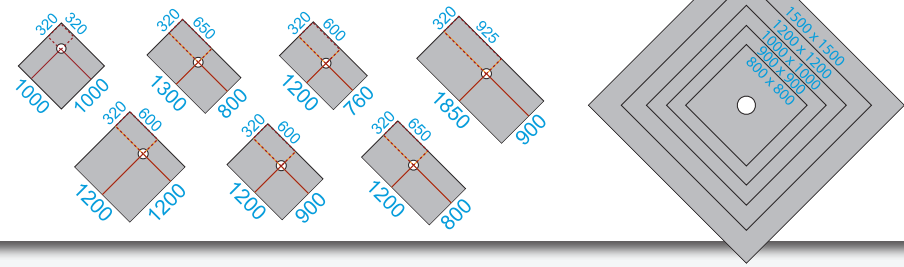

**Drain Parts**

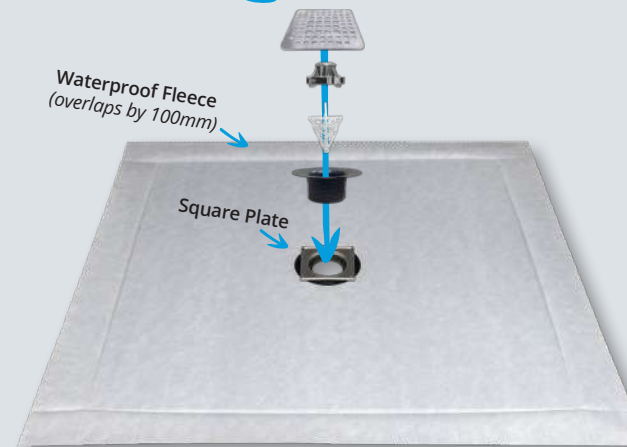

**Drain Height (mm)**



Data	
Product	Performance Litres per min
360°	30

**Wetroom Tray**  
*Pre-formed slope*

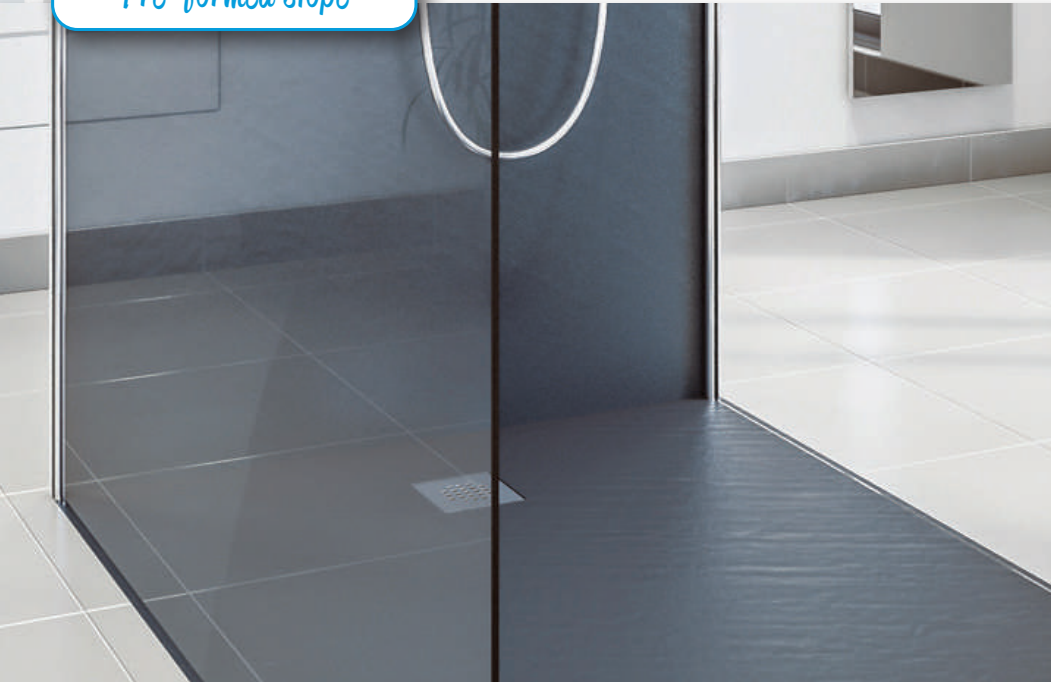

**Key Benefits**

- Stylish design finish
- Pre-formed slope
- Fully waterproof
- Centre or offset drain



**Stone effect, pre-formed, resin shower floor former**

The Decotray is an excellent choice for designing a stylish, sloping floor with a visually appealing aesthetic and a high-quality finish. It is crafted from Marmoxite, a patented resin-bound synthetic stone.

The design ensures that it not only looks stunning but also provides a functional and long-lasting solution for wetroom floors. Whether you prefer the sleek, modern look of Slate Grey or the crisp, clean appearance of Polar White, the Decotray delivers a premium finish that enhances any space.

Find out more, including fitting instructions at:  
[www.marmox.co.uk](http://www.marmox.co.uk)

**Sizes**

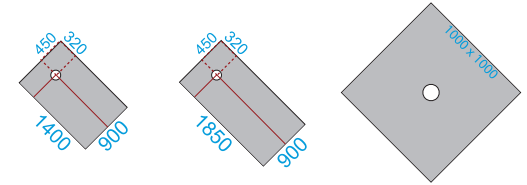

**Drain Parts**

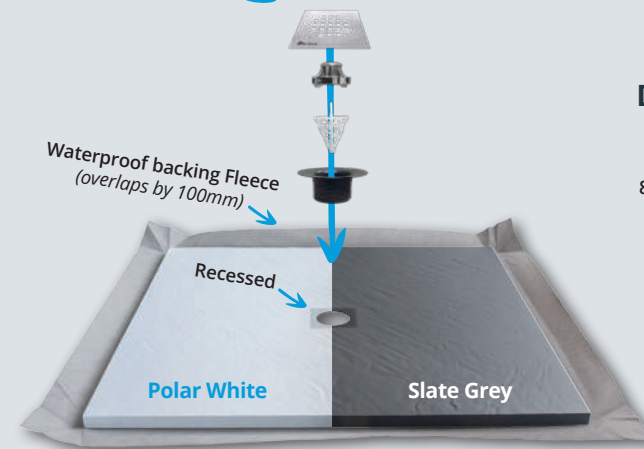
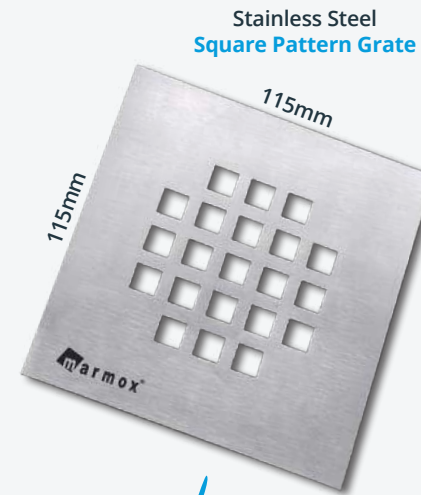

**Drain Height (mm)**



Data	
Product	Performance
360°	Litres per min
	30

**Linear Drain**  
*Create your own slope*

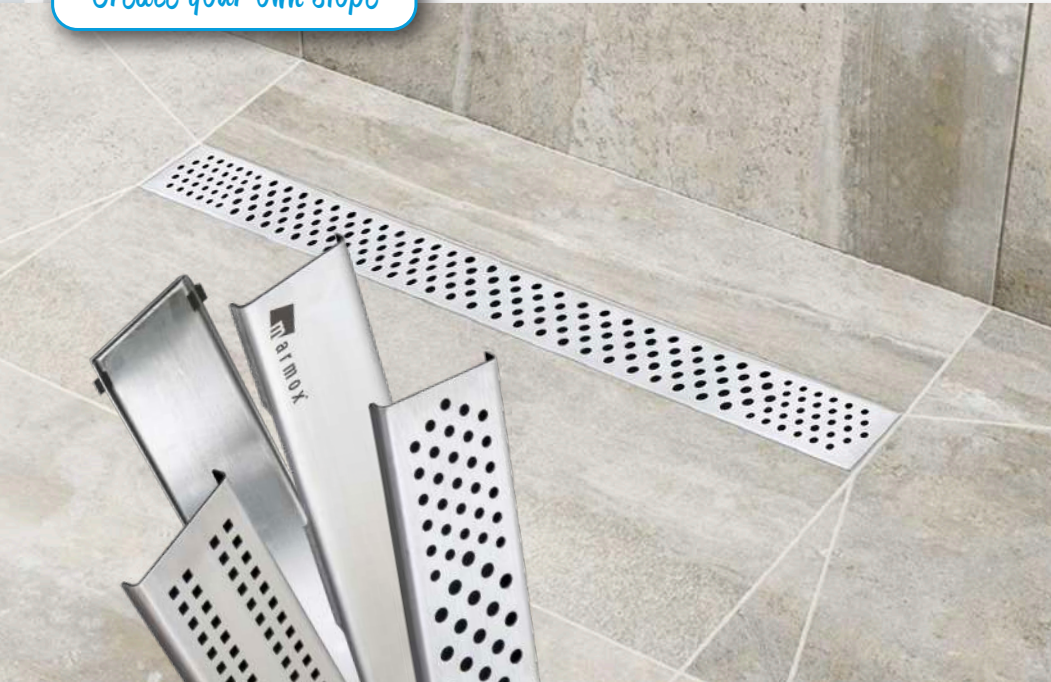

**Key Benefits**

- Create bespoke slope
- Square or linear drain
- Slimline or 360° waste
- Various grate options



**Create your own shower slope**

Minilay provides the flexibility and freedom to transform any concrete floor into a tileable wetroom floor.

Marmox Minilay is a drainage gully which has been factory fitted into a height adjustable frame, which itself sits within a small rigid board. This small board provides a solid surface immediately around the drain from which the slope of the shower floor can be continued with the screed.

Available with a twistable 360° or a slimline waste, in Linear and Square drain options.

Find out more, including fitting instructions at:  
[www.marmox.co.uk](http://www.marmox.co.uk)

**Drain Kit**



**Drain Parts**

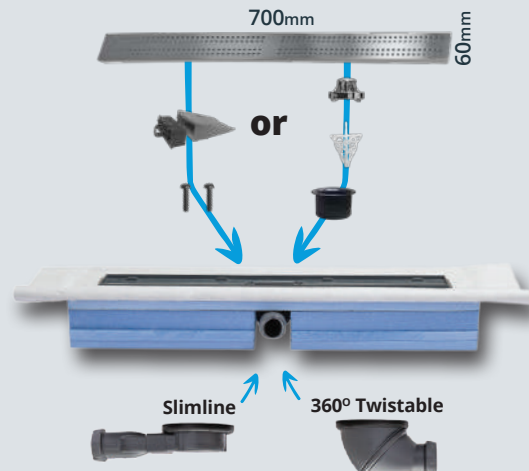
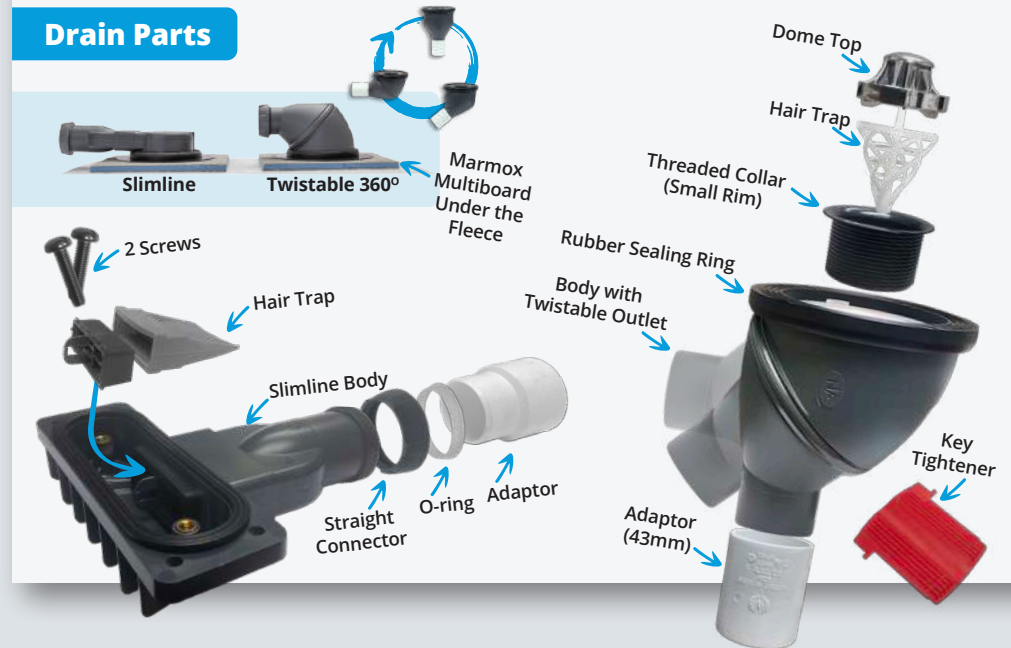

**Drain Height (mm)**



**Sizes & Data**

Product	Connection (mm)	Performance Litres per min
360°	43	30
Slimline	50	33.6

**Square Drain**  
*Create your own slope*

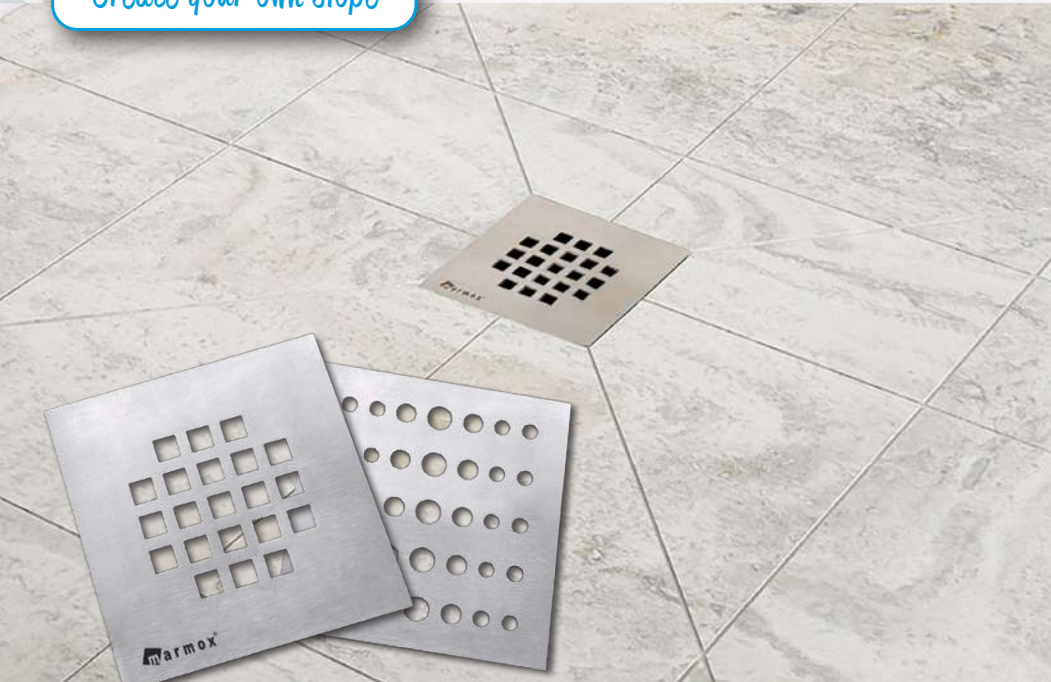

**Key Benefits**

- Create bespoke slope
- Square or linear drain
- Slimline or 360° waste
- Various grate options



**Create your own shower slope**

Minilay provides the flexibility and freedom to transform any concrete floor into a tileable wetroom floor.

Marmox Minilay is a drainage gully which has been factory fitted into a height adjustable frame which itself sits within a small rigid board. This small board provides a solid surface immediately around the drain from which the slope of the shower floor can be continued with the screed.

Available with a twistable 360° or a slimline waste, in Linear and Square drain options.

Find out more, including fitting instructions at:  
[www.marmox.co.uk](http://www.marmox.co.uk)



**Drain Parts**

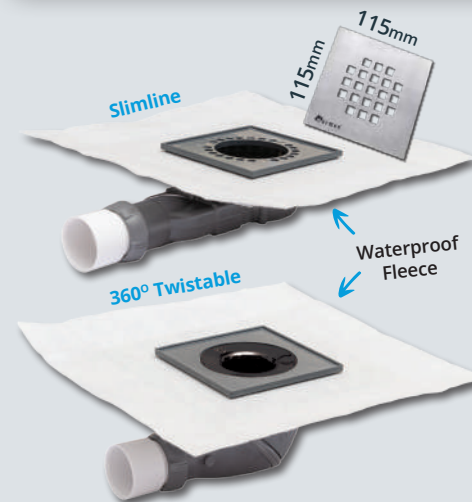
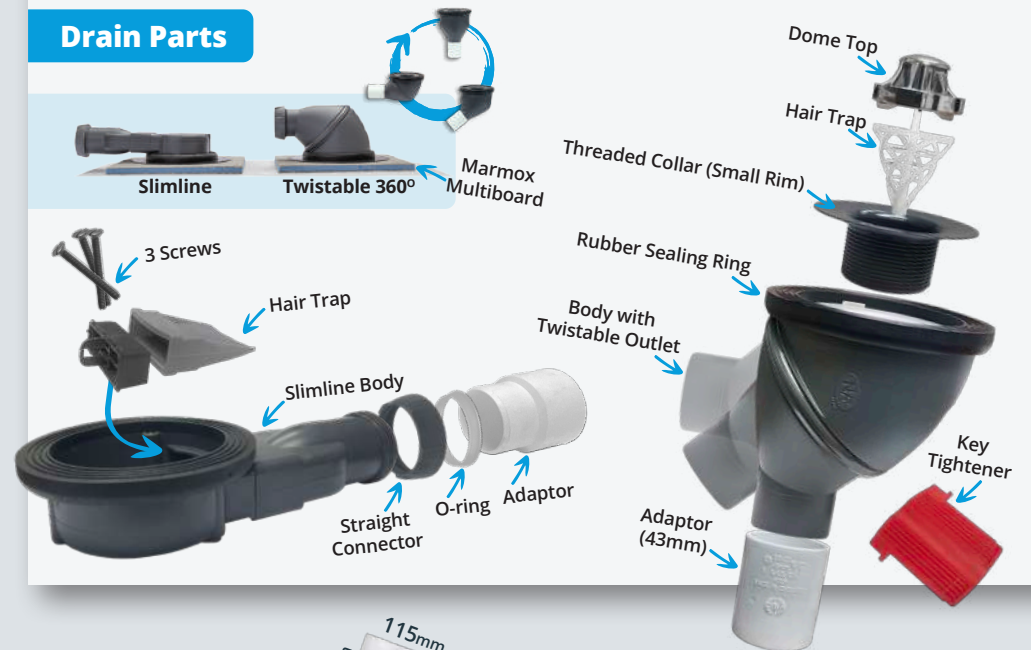

**Drain Height (mm)**



**Sizes & Data**

Product	Connection (mm)	Performance Litres per min
360°	43	30
Slimline	50	33.6

## Accessories

### Marmox MSP360:

Premium Adhesive and Sealant. Ultra high performance, professional, heavy duty. Fully waterproof - it even cures under water!



### Marmox Waterproof Fleece:

Fully waterproof fleece for tanking wet areas. For use with or without Multiboard.



### Marmox S/A Waterproof Tape:

10 metre roll of the popular Marmox tanking tape for use with Marmox Multiboards in all wet areas.



### Marmox Waterproof

**Corners:** Use these pre-formed fleece corners for easy waterproof protection. Available for Internal and external corners.



**Marmox Washers:** Available in buckets (500) or bags (100), in metal or plastic. **Note:** plastic washers only available by the bag.



## marmox multiboard

Waterproofing • Insulating • Drylining

The tried and trusted construction material which merges water proofing, insulation and structural strength into a reliable, BBA certified board. Lightweight and easy to cut with minimal dust, it accommodates tiling, plastering, and rendering, both indoors and outdoors.

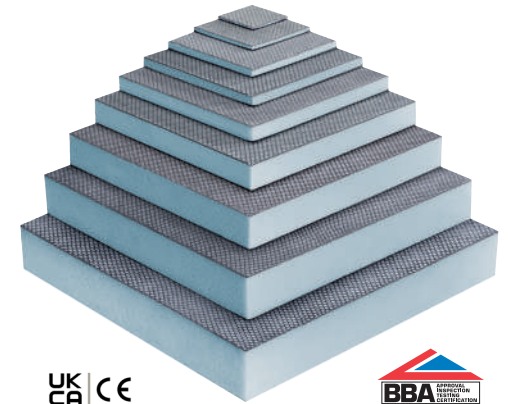

UK CA CE



## Tile it • Plaster it • Render it

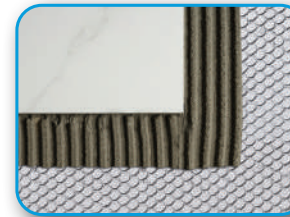

**Tiles** - Ultimate substrate for tiles. Hold up to 100kg/m<sup>2</sup>



**Plaster** - No need to PVA, plaster directly onto them

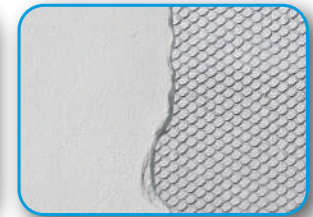

**Render** - Will support many different types of render

Also See the Marmox Multiboard Product & Installation Guide



Download Now From Our Marmox website

[www.marmox.co.uk](http://www.marmox.co.uk)



**Always look out for the  
honeycomb finish**

*It means... Genuine Marmox and an  
ultra-strong surface for adhesion!*

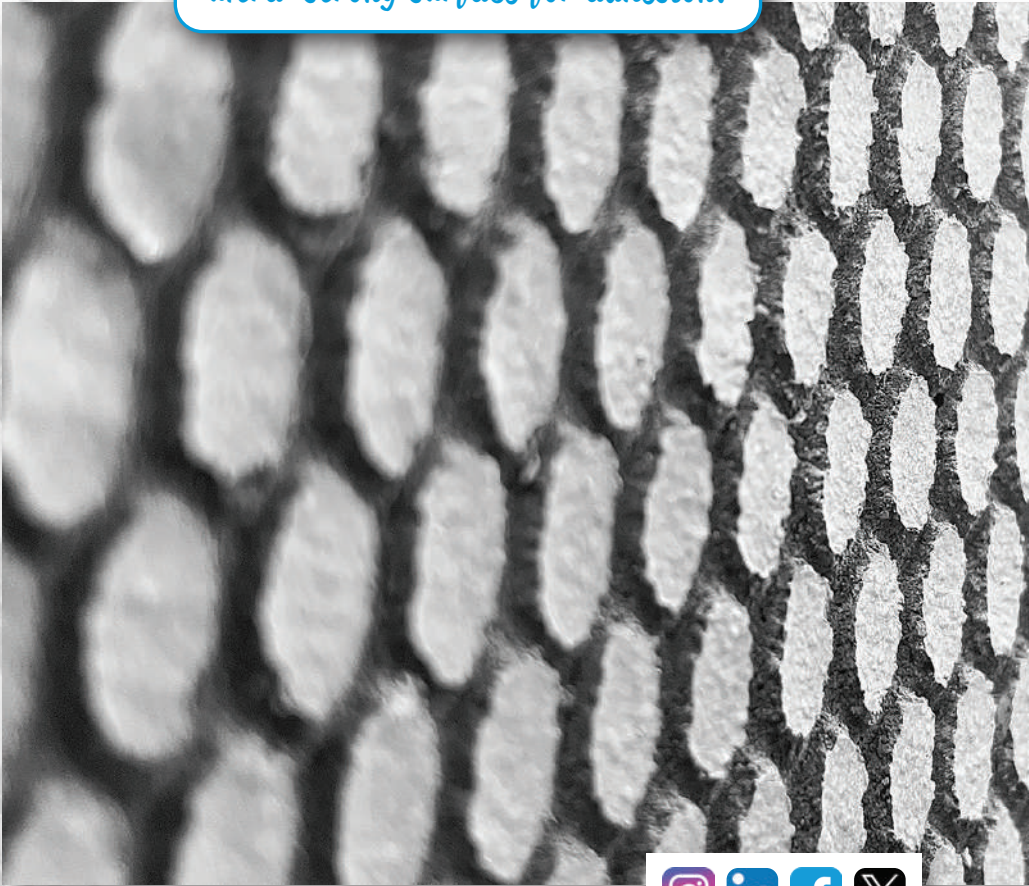

**Marmox UK Ltd**

Caxton House,  
101-103 Hopewell Drive,  
Chatham, Kent. ME5 7NP  
United Kingdom

**For information and advice:**

Tel: 01634 835290  
Email: [sales@marmox.co.uk](mailto:sales@marmox.co.uk)  
Web: [www.marmox.co.uk](http://www.marmox.co.uk)

